

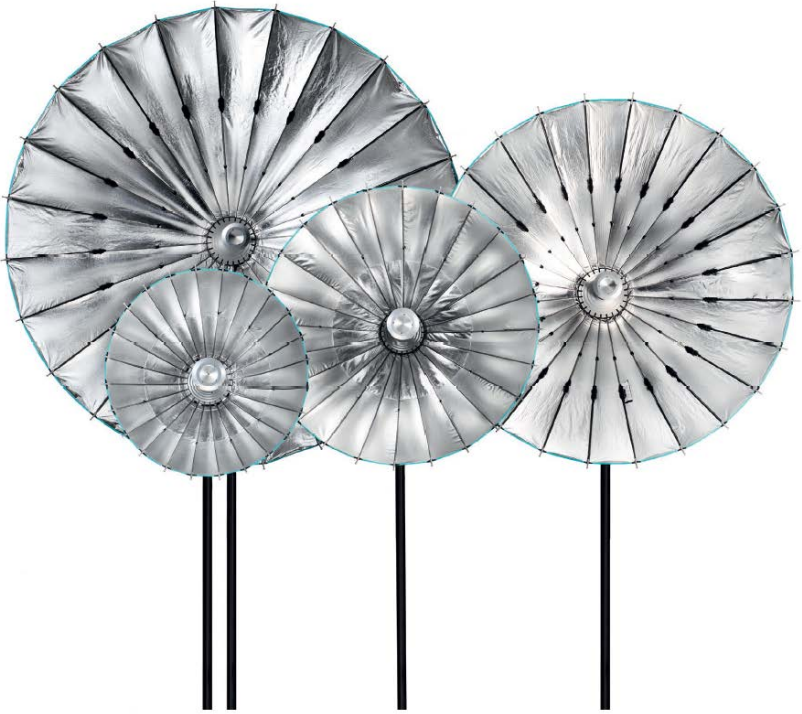

FT SYSTEM

Operating instructions | Bedienungsanleitung | Mode d'emploi



OPERATING INSTRUCTIONS | BRONCOLOR FT SYSTEM

Before use

Please read all the information contained in these operating instructions carefully. They contain important instructions for use, safety and maintenance of the appliance. Keep these operating instructions in a safe place and pass them on to further users if necessary. Observe the safety instructions.

Contents

Attention! Important safety instructions - Read carefully before starting up! 

1. Setting up a Para
2. Assembly of bulb unit, rod and lamp head
3. HMI stop clip for diffusers and light grids
4. Transport restraint for lamp
5. Changing the bulb
6. Start-up with tungsten lamp
7. Start-up with HMI lamp
8. Start-up with the HMI FT System
9. Operating modes
10. Display on ballast unit
11. Protective circuits in the ballast unit
12. Fault diagnosis table
13. Operating broncolor ballast units from a motor-generator set
14. Controls and display elements on ballast unit HMI 800.1600
15. Technical data, ballast unit HMI 800.1600
16. Controls and display elements, Para and Lamp
17. Technical data Tungsten FT
18. Technical data HMI FT
19. Order numbers for spare parts and accessories
20. Environmental protection information

ATTENTION! IMPORTANT SAFETY INSTRUCTIONS



broncolor FT System

- > Read carefully before starting up!
- > The equipment should be used exclusively by qualified personnel.
- > Use only a complete and undamaged connection cable. Position the cable so that it will not be tripped over or make contact with hot surfaces. If an extension cable is needed, it must have an adequate cross-section for the ballast unit to be supplied. Cables rated for less amperage than the appliance may overheat.
- > Never use a focusing rod with damaged contact pins.
- > For safety reasons, the ballast unit may only be operated with an earthed mains plug. When the appliance is switched on, the yellow LED light (3) must illuminate. If the LED does not illuminate, the unit needs servicing.
- > Avoid incorrect use of any kind, and be particularly careful not to obstruct the natural circulation of air that keeps the bulb unit and ballast unit cool.
- > The ballast unit, lamp head, focusing rod and bulb unit must never be exposed to moisture. This could cause dangerous electric discharges on contact!
- > To minimise the risk of fire, electric shock, or injury to persons, use exclusively accessories recommended by the manufacturer.
- > The equipment must not be used in explosion-hazard areas.
- > The bulb unit and accessory attachments may heat up to high temperatures. Please handle with care.
- > To protect against the effects of radiated heat, the bulb unit must not be directed at flammable surfaces and/or surfaces sensitive to heat, or at any objects from less than a minimum distance of 2 meters.
- > In order to achieve maximum service life from the HMI bulb, the heating up process of approx. 1 minute should not be interrupted; avoid repeated switching on and off.
- > Use the bulb unit only with undamaged safety glass. Bulbs can burst. The safety glass will retain hot fragments.
- > Like natural daylight, HMI/MSR light contains a certain proportion of UV radiation. The safety glass reduces the UV content to safe levels for normal operating distances. When used at a close operating distance, limit the exposure time of unprotected skin. Due to the great intensity, avoid looking directly at the light source.
- > Take special care of your equipment, particularly when there are children present! Never leave the flash equipment unattended!
- > Before replacing the bulb or safety glass, disconnect the lamp and ballast unit from the power supply.
- > Before the equipment is cleaned or serviced, and while it is not in use, the ballast unit must be switched off and completely disconnected from the power supply. Never pull on the cable itself: pull only on the plug body.
- > Allow time for the ballast unit and lamp to cool before you stow them.

- > Units with noticeable damage or which have been dropped must not be started up. Contact a broncolor service station. Service work or repairs must always be carried out by a specialist.
 - > To ensure safe, reliable long-term mechanical and electrical operation, use only original spare parts. Incorrect assembly can cause dangerous contact voltages, even on connected units.
 - > For transport fit the transport restraint provided to protect the bulb and bulb unit.
 - > The FT System with lamp head, focusing rod and bulb unit can only be used in complete plug-in form. A safety interlock in the focusing rod prevents switching on without the bulb unit fitted.
 - > When fitting the bulb unit to the focusing rod, the retaining screw must be tightened before use to prevent the bulb unit falling off.
 - > When using diffusers and light grids, the stop ring must be fastened to the focusing rod.
 - > Observe the correct Watt setting on the lamp head HMI FT800.1600. It must correspond to the bulb fitted (800 W or 1600 W).
 - > With the FT System, use only the appropriate, heat-resistant Para reflectors.
-

1. SETTING UP A PARA

1.1 Settings Para 88 HR / Para 133 HR

Before the Para is opened, turn it a few times each way to bring it into shape.

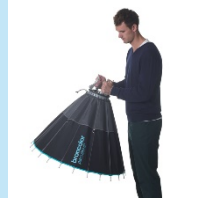

To open the Para, the levers on opposite sides of the ring must be pressed down simultaneously. Observe the markings on the clamping ring.



Put the focus holder in place and turn it clockwise until the latching mechanism engages.



Mount the Para with the focus holder on a stand with tilt head. Tighten the clamping lever securely.

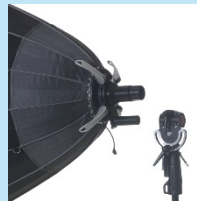

1.2 Folding Para 88 HR / Para 133 HR

To fold up the Para proceed in the reverse order. Before changing the bulb, the bulb unit must have cooled down completely. Stow the product in the transport bag supplied.

1.3 Settings Para 177 / Para 222

Before opening the Para, it must first be mounted on a stand with tilt head. A special tilt head with a hand crank is available as an accessory (33.477.00).

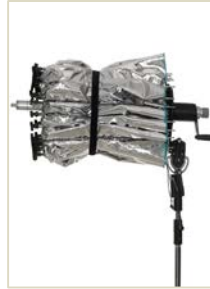

Now remove the outer belt.



Loosen up the Para and remove the inner belt.



Bring the Para into shape until the ribs click into position. Turn the hand crank to tension the Para.



1.4 Folding Para 177 / 222

To fold up the Para proceed in the reverse order. Before changing the bulb, the bulb unit must have cooled down completely. The ribs must be loosened and folded before fitting the belts. Stow the product in the transport bag supplied.

2. ASSEMBLY OF BULB UNIT, ROD AND LAMP HEAD

Before assembly, remove the transport protection.



Fit the bulb unit with the bulb to the focusing rod. To ensure reliable ignition, the blue marked contact of the bulb must be plugged to the blue side of Focusing tube. Turn the retaining screw clockwise to the stop.

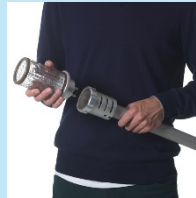

Fit the focusing rod to the Para from the front.



Fit the counter reflector to the thread on the bulb unit.

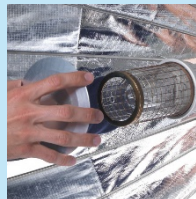

Fit the appropriate lamp head (HMI or tungsten) to the focusing rod. Check that the lamp head is properly latched.

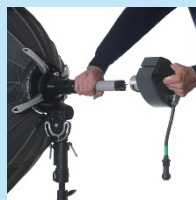

Observe the correct Watt setting on the lamp head HMI FT800.1600. It must correspond to the bulb fitted (800 W or 1600 W). (See Section 7)

3. STOP CLIP FOR DIFFUSERS AND LIGHT GRIDS

When using diffusers and light grids, always fit the stop clip to the focusing rod. When defocusing, this prevents the bulb unit contacting the diffuser or the light grid, which could be a fire hazard.

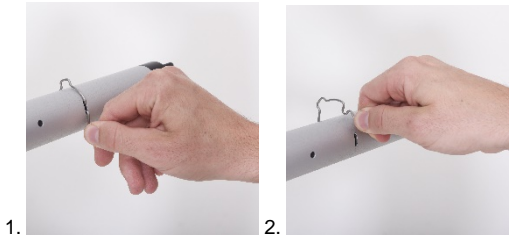

4. TRANSPORT RESTRAINT FOR LAMP

For transport, the transport restraint provided must be fitted to protect the bulb and bulb unit. The transport restraint passes through the grid of the bulb unit and over the bulb. Never attempt to use the bulb unit with the transport restraint in place!

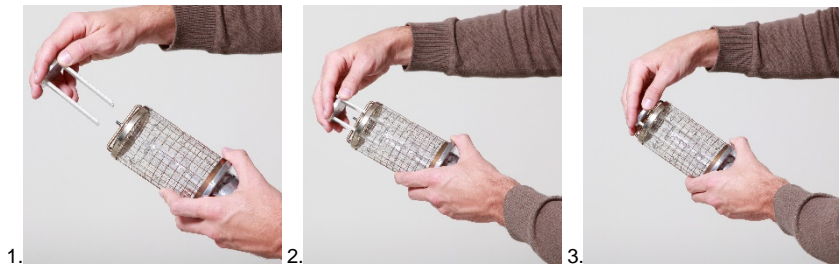

5. CHANGING THE BULB

Before changing the bulb, the lamp head HMI FT800.1600 must be disconnected from the ballast unit, or the Tungsten FT lamp head must be disconnected from the power supply. Before changing the bulb, the bulb unit must have cooled down completely.

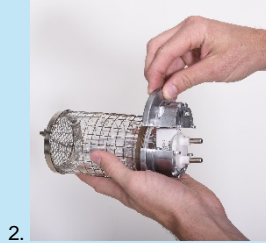

Use the hexagon wrench (Allen key) supplied in the kit to undo the two screws on the bulb unit. Lift off the top half of the housing.



Tilt the bulb to take it out of the bulb unit.
Fit a new bulb and replace the top half of the housing.

6. START-UP WITH LAMP HEAD TUNGSTEN FT

Before start-up, check that the voltage (120 V or 230 V) of the halogen lamp corresponds to the mains power supply. Connect the lamp cable to a power socket and turn the on/off switch (13) for start-up.

7. START-UP WITH LAMPHEAD HMI

The lamphead HMI FT800.1600 can be operated with an 800 W or a 1600 W bulb. Before start-up, the Watt setting must be correctly set on the lamp head using the Watt setting screw: A (800 W) or B (1600 W).

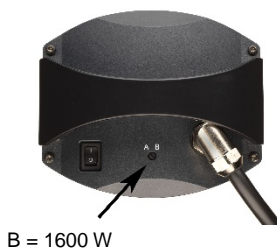
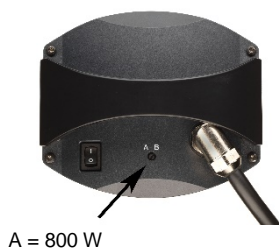

8. START-UP WITH THE HMI FT SYSTEM

The ballast unit HMI 800.1600 is a flicker-free ballast unit that is suitable for mains voltages from 90 V to 265 V. It adjusts automatically to the mains voltage applied.

The unit is suitable for operation with hot-restrike (HR) lamps. This means that the lamp may be switched on again at any time while hot, making waiting time unnecessary. For safety reasons, the high ignition voltages required for this purpose call for a faultless earth conductor. For this reason the unit must only be connected to a power supply with an earthed mains plug. Correct functioning of the earth conductor is indicated by the control lamp (3).

8.1 Connecting lamp head HMI FT800.1600

Connect the lamp head to the ballast unit, and the ballast unit to the earthed mains supply. Switch on the mains switch (2) of the ballast unit and check whether the earth control LED (3) illuminates. If this is not the case, for safety reasons disconnect the ballast unit immediately from the mains and check the earth conductor.

8.2 Start-up of lamp head HMI FT800.1600 with ballast unit

Operate switch (9) on the lamp and press button (4) on the ballast unit. The bulb fires and starts operating. By operating the switch (9) on the lamp head or on the ballast unit (4), the light can be switched off again.

The ballast unit has an automatic warming-up circuit, which heats the bulb quickly to its operating temperature. Except in an emergency avoid switching off the unit during the warming-up phase, because this shortens the life of the bulb. The optimum colour temperature is reached after about one minute.

Should the bulb fail to trigger, the ballast unit will switch off the ignition sequence after 2 seconds, and button (4) on the ballast unit blinks (see Section 7). To make another attempt to start, press the button (4) on the ballast unit or (9) on the lamp head. To protect the igniter circuit, this is blocked for 30 seconds after about ten attempts at ignition. Afterwards further ignition attempts are possible.

Take care that the ventilation slots on the ballast unit and on the bulb unit are not obstructed.

8.3 Output regulation of ballast unit HMI 800.1600

The output regulator (8) on the ballast unit can be used to set the desired light output (setting range 50 % - 100 %). When setting the output, it is important to remember that, depending on the bulb used, the colour temperature can change slightly with the output. When the bulb is switched on, the output is automatically set to the maximum so that the bulb heats up as quickly as possible. The duration of this depends on the bulb temperature when it is switched on, and is likely to be between 5 and 60 seconds. At the end of this period, the unit adjusts automatically to the setting of regulator (8)

8.4 Notes on HMI 1600 Bulb

Broncolor HMI delivers 1600 torch, which show through the blue highlighted contact the optimal insertion position of the burner. If burners are available from other sources, the optimal insertion position can be elicited on the basis of the longer electrode feeder (see picture).

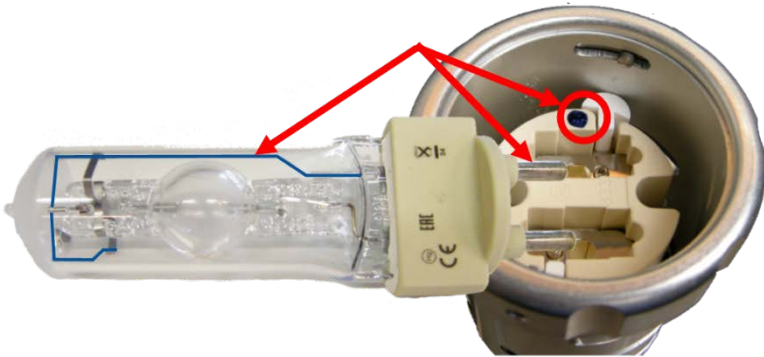

8.5 Ballast unit HMI 800.1600 power control

With the Power Controller (8) at the ballast unit the desired light output can be set (adjustment range 50% - 100%) It should be noted, that can easily change the color temperature with the performance, depending on the type of burner used. After turning on the burner, the power is automatically on fully controlled in order to obtain an optimal and rapid heating of the burner. The duration depends on the burner temperature when switched on and can be between 5 and 60 seconds. Then the device automatically adjusts again to the controller (8) set value.

9. OPERATING MODES

The ballast unit has three different operating modes, which can be selected by pressing the button (5) on the ballast unit. The mode selected is indicated by illumination of an LED (5 a-c):

low noise: For extremely noise-sensitive shoots, up to 100 fps

optimal: For "normal" shoots at up to 800 fps

high speed: For high-speed shoots at up to 2000 fps

10.DISPLAY ON BALLAST UNIT



Mains switch (2)

Illuminated: mains voltage is present. The unit is switched on.

Not illuminated: The unit is switched off or not connected to the mains voltage.

Indicator for earth conductor (3)

Illuminated: The unit is switched on and the earth conductor is correctly connected.

Not illuminated: The unit is switched off or the earth conductor is not correctly connected.

Lamp control display (4)

Illuminated: The lamp is switched on and the unit is functioning correctly.

Not illuminated: The lamp and/or the ballast unit is switched off or not connected to the mains supply.

(5a–c) operating mode display

(7a, b) display shows that the lamp has been identified

11.PROTECTIVE CIRCUITS IN THE BALLAST UNIT

The HMI 800.1600 ballast unit features monitoring electronics with detailed fault diagnosis.

Overvoltage protection: If the applied voltage is greater than 260 V, the ballast unit either switches off automatically, or cannot be switched on. Button (4) blinks to indicate this.

Low-voltage protection: If the applied voltage is below 90 V, the ballast unit either switches off automatically, or cannot be switched on. Button (4) blinks to indicate this.

Current limitations: When a 1600W lamp is operated on a mains voltage below 95V, the lamp output is automatically reduced to prevent the current exceeding 18 A. Button (7a) blinks to indicate this. Should the voltage rise above 95 V again during operation, the output will remain unchanged at the reduced level, so as to avoid continual changes in lighting.

Thermal monitoring: If the operating temperature of the unit is exceeded, the ballast unit automatically regulates the output gradually down to max. 50 %. This lowering of the output allows the user time to recognise the situation and to prevent or delay a total shutdown. If a shutdown occurs, for safety reasons, the unit does not automatically switch on again. The lamp must be switched on again manually.

Igniter circuit protection: If the bulb fails to trigger, ignition is blocked for 30 seconds after about ten attempts at ignition in succession.

12. FAULT DIAGNOSIS TABLE

Fault detected	How to reset	Start/Stop (4)	high speed (5a)	normal (5b)	low noise (5c)	800 W (7a)	1600 W (7b)	Earth (3)
Short circuit	Restart	blinks	blinks	off	off	(on)	(on)	on
Bulb goes out	Restart	blinks	off	blinks	off	(on)	(on)	on
Wrong lamp detected	Restart	blinks	off	off	blinks	(on)	(on)	on
Supply voltage over 265 VAC	Restart	blinks	blinks	blinks	off	(on)	(on)	on
Supply voltage below 85 VAC	Restart	blinks	blinks	off	blinks	(on)	(on)	on
Operating temperature exceeded	Allow to cool	blinks	off	off	off	(on)	(on)	on
More than 10 ignition attempts	Allow to cool	blinks	off	blinks	blinks	(on)	(on)	on
Technical fault	Service station	blinks	blinks	blinks	blinks	blinks	blinks	on

13. OPERATING BRNOCOLOR BALLAST UNITS FROM A MOTOR-GENERATOR SET

Ballast units are suitable for operation with motor-generator sets, in so far as the voltage under all load conditions (including capacitive loads) is within the tolerance limits of 200 – 260 V or 95 – 135 V. Experience shows that this usually requires electronically-stabilised motor-generators. Unstabilised motor-generators can produce voltage peaks of 300 V and over. This may cause damage for which Bron Elektronik AG accepts no liability.

14. CONTROLS AND DISPLAY ELEMENTS BALLAST UNIT HMI 800.1600

- 1 Grip
- 2 Main switch 0/I with integral fuse
- 3 Earth conductor indicator
- 4 Button, lamp On/Off
- 5 Button for selecting operating mode
- 5a-c Indicators for selected operating mode
- 6 Mains cable socket
- 7 Lamp plug socket
- 7a-b Indicators show which lamp has been identified
- 8 Rotary knob for adjusting output (dimmer)

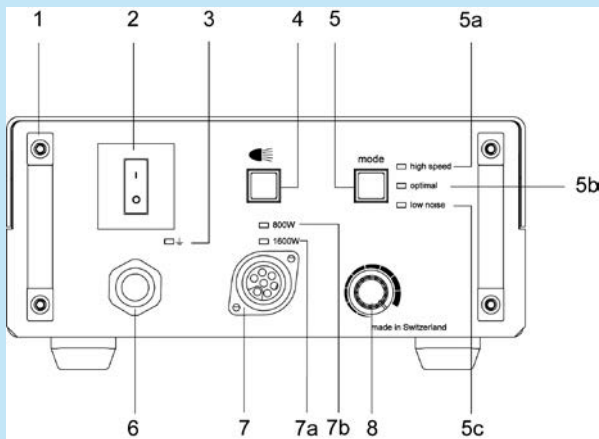

15. TECHNICAL DATA, BALLAST UNIT HMI 800.1600

Supply power rating	1800 VA
Mains voltage	90 – 265 V
Mains frequency	50/60 Hz
Current draw 20 A	(90 VAC), 15 A (120 VAC), 8 A (230 VAC)
Power factor	99 % at 110 V / 95 % at 230 V
Lamp frequency	square-wave 50, 400, 1000 Hz
Regulation zone	50 – 100 %
Lamp detection	automatic
Start-up characteristics	cold start and hot restrike capability
Dimensions (lxbxh)	360 x 240 x 120 mm (142 x 94 x 47")
Weight	6.9 kg (15.2 lbs)

16. CONTROLS AND DISPLAY ELEMENTS, FT SYSTEM

- 9 On/off Switch HMI
- 10 Watts setting screw
- 11 Lamp cable HMI
- 12 Tungsten Fuse
- 13 On/off Switch Tungsten
- 14 Lamp cable Tungsten
- 15 Clasp for focusing device
- 16 Electrical pins
- 17 Stop ring for Diffuser and Lightgrid
- 18 Set screw
- 19 Lamp device with bulb
- 20 Counter reflector
- 21 Trasnport lock bulb

Lamp head HMI FT800.1600

Lamp head Tungsten FT

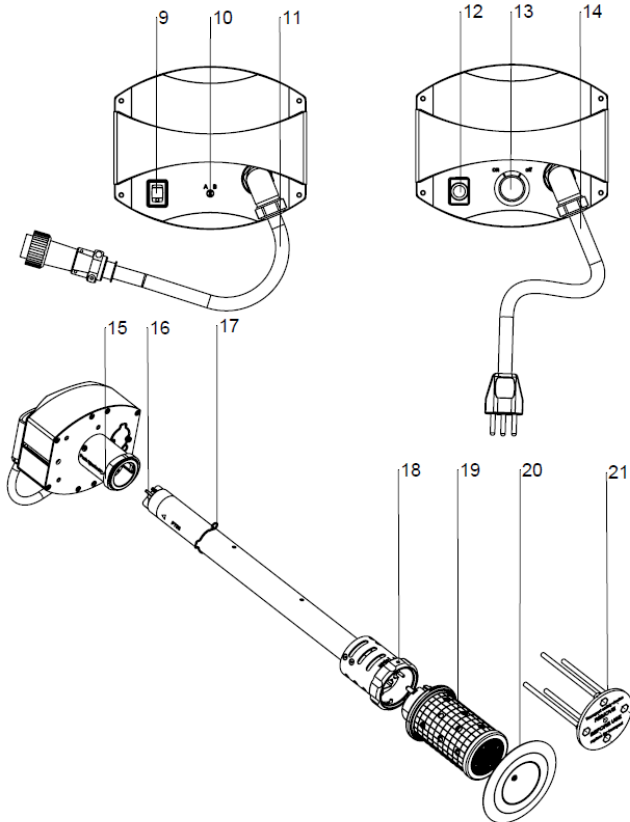

17. TECHNICAL DATA TUNGSTEN FT

Output	1000/2000 W
Bulb socket	G22
UV protection	Protecting glass with mit UV-Coating
Storage temperature	-10 to 60°
Ambient air temperature	0-50°
Range of application	No water protection
Para angle	-90 to +90°

18. TECHNICAL DATA HMI FT

Output	800/1600 W
Bulb socket	G22
UV protection	Protecting glass with mit UV-Coating
Preparation time HMI	1 min. until full power
Storage temperature	-10 to 60°
Ambient air temperature	0-50°
Range of application	No water protection
Para angle	-90 to +90°

19. ORDER NUMBERS FOR SPARE PARTS AND ACCESSORIES

Electronic ballast unit HMI 800.1600	41.104.XX
Lamphead HMI FT800.1600	42.110.00
Lamphead Tungsten FT	42.112.00
Extension cable 7.5 m	44.202.00
Extension cable 10 m	44.203.00
Extension cable 20 m	44.204.00
Focusing device Para 88/133	33.504.00
Tilt head Para 88 - 222	33.505.00
Tilt head with crank handle for Para177 / Para 88 FT kit	33.477.00
Para 88 FT kit	41.173.00
Para 133 FT kit	41.175.00
Para 177 FT kit	41.177.00
Para 222 FT kit	41.178.00
Focusing tube FT88	33.713.00
Focusing tube FT133	33.715.00
Focusing tube FT177	33.717.00
Focusing tube FT222	33.718.00
Focusing tube F88	33.703.00
Focusing tube F133	33.705.00
Focusing tube F177	33.707.00
Focusing tube F222	33.708.00
Lamp device HMI FT800 with bulb and counter-reflector	42.109.00
Lamp device HMI FT1600 with bulb and counter-reflector	42.111.00
Lamp device Tungsten FT1000 (120 V) with bulb and counter-reflector	42.115.00
Lamp device Tungsten FT2000 (230 V) with bulb and counter-reflector	42.113.00
Daylight bulb 800 W UVC CSR/SE/HR	44.110.00
Daylight bulb 1600 W UVC CSR/SE/HR	44.107.00
Halogen bulb 1000W / 120V, G22	34.272.00
Halogen bulb 2000W / 230V, G22	34.270.00
Halogen bulb 2000W / 120V, G22	34.271.00
Flash Bag 2 without inlay	36.532.01
Accessory Bag	36.535.00
Trolleybag foldable for Para 177/222	36.521.00
Transport case for FT System	36.523.00

20. ENVIRONMENTAL PROTECTION INFORMATION

At the end of its useful life, this product may not be disposed of as normal household waste, but should be taken to a collection point for the recycling of electrical and electronic appliances. The materials are recyclable according to their markings. By re-use, recycling, or other form of using old appliances you are making an important contribution to the protection of our environment. Please ask your sales partner or local authorities for the appropriate disposal point.

